

Smart choice for power™

xantrex™

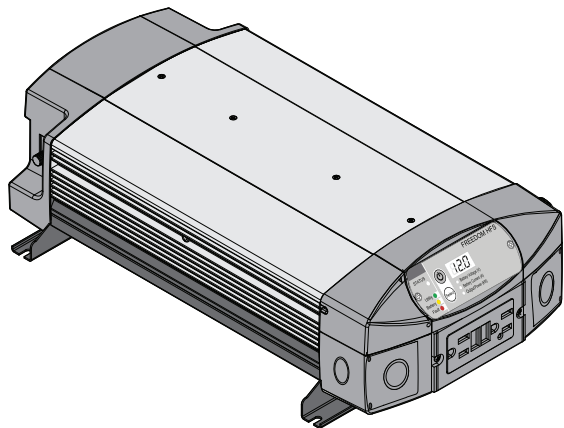

Product image shown may vary from actual product. See features for comparisons.

Freedom HFS Inverter/Chargers

Owner's Guide

Model Product Numbers

807-1055
807-1055-02
807-2055
807-2055-01
807-2055-02

Copyright © 2015 Schneider Electric. All Rights Reserved. All trademarks are the property of Schneider Electric SE, its subsidiaries and affiliated companies.

Exclusion for Documentation

UNLESS SPECIFICALLY AGREED TO IN WRITING, SELLER

(A) MAKES NO WARRANTY AS TO THE ACCURACY, SUFFICIENCY OR SUITABILITY OF ANY TECHNICAL OR OTHER INFORMATION PROVIDED IN ITS MANUALS OR OTHER DOCUMENTATION;
(B) ASSUMES NO RESPONSIBILITY OR LIABILITY FOR LOSSES, DAMAGES, COSTS OR EXPENSES, WHETHER SPECIAL, DIRECT, INDIRECT, CONSEQUENTIAL OR INCIDENTAL, WHICH MIGHT ARISE OUT OF THE USE OF SUCH INFORMATION. THE USE OF ANY SUCH INFORMATION WILL BE ENTIRELY AT THE USER'S RISK; AND

(C) REMINDS YOU THAT IF THIS MANUAL IS IN ANY LANGUAGE OTHER THAN ENGLISH, ALTHOUGH STEPS HAVE BEEN TAKEN TO MAINTAIN THE ACCURACY OF THE TRANSLATION, THE ACCURACY CANNOT BE GUARANTEED. APPROVED CONTENT IS CONTAINED WITH THE ENGLISH LANGUAGE VERSION WHICH IS POSTED AT WWW.XANTREX.COM.

Document Part Number

975-0727-01-01

Date and Revision

September 2015 Rev C

Product Numbers

Freedom HFS 1055 (1000-watt) Models:

807-1055 (Freedom HFS 1055 120VAC Standard Model)

807-1055-02 (Freedom HFS 1055 120VAC EMS Model)

Freedom HFS 2055 (2000-watt) Models:

807-2055 (Freedom HFS 2055 120VAC Standard Model)

807-2055-01 (Freedom HFS 2055 120VAC Truck Model)

807-2055-02 (Freedom HFS 2055 120VAC EMS Model)

Contact Information

Telephone: +1 800 670 0707

+1 408 987 6030

Web: www.xantrex.com

Information About Your System

As soon as you open your product, record the following information and be sure to keep your proof of purchase.

Serial Number _____

Product Number _____

Purchased From _____

Purchase Date _____

To view, download, or print the latest revision, visit the website shown under Contact Information.

About This Guide

Purpose

The purpose of this Owner's Guide is to provide explanations and procedures for operating, maintaining, and troubleshooting a Freedom HFS Sine Wave Inverter/Charger for Recreational, Fleet Vehicle, or Marine installations.

For complete information to help in installing a Freedom HFS Sine Wave Inverter/Charger see the Freedom HFS Sine Wave Inverter/Charger Installation Guide (Doc. Part Number: 975-0726-01-01).

Scope

The Guide provides safety and operating guidelines as well as information on configuring the inverter/charger. It also provides information about troubleshooting the unit. It does not provide details about particular brands of batteries. You need to consult individual battery manufacturers for this information.

Audience

The Guide is intended for users and operators of the Freedom HFS Sine Wave Inverter/Charger.

Related Information

You can find more information about Xantrex products and services at www.xantrex.com.

NOTE: The Installation Guide (Document Part Number: Freedom HFS Sine Wave Inverter/Charger Installation Guide (Doc. Part Number: 975-0726-01-01)) is intended for qualified personnel. Qualified personnel have training, knowledge, and experience in:

- Installing electrical equipment (up to 1000 volts).
- Applying all applicable installation codes.
- Analyzing and reducing the hazards involved in performing electrical work.
- Selecting and using Personal Protective Equipment (PPE).

Important Safety Instructions

IMPORTANT: READ AND SAVE THIS OWNER'S GUIDE FOR FUTURE REFERENCE.

This guide contains important safety instructions for the Freedom HFS Sine Wave Inverter/Charger that must be followed during operation and troubleshooting. **Read and keep this Owner's Guide for future reference.**

Read these instructions carefully and look at the equipment to become familiar with the device before trying to install, operate, service or maintain it. The following special messages may appear throughout this bulletin or on the equipment to warn of potential hazards or to call attention to information that clarifies or simplifies a procedure.



The addition of either symbol to a "Danger" or "Warning" safety label indicates that an electrical hazard exists which will result in personal injury if the instructions are not followed.



This is the safety alert symbol. It is used to alert you to potential personal injury hazards. Obey all safety messages that follow this symbol to avoid possible injury or death.

DANGER

DANGER indicates an imminently hazardous situation, which, if not avoided, will result in death or serious injury.

WARNING

WARNING indicates a potentially hazardous situation, which, if not avoided, can result in death or serious injury.

CAUTION

CAUTION indicates a potentially hazardous situation, which, if not avoided, can result in moderate or minor injury.

NOTICE

NOTICE indicates a potentially hazardous situation, which, if not avoided, can result in equipment damage.

IMPORTANT: These notes describe things which are important for you to know, however, they are not as serious as a caution or warning.

Safety Information

1. **Before using the inverter/charger, read all instructions and cautionary markings on the unit, the batteries, and all appropriate sections of this manual.**
2. Use of accessories not recommended or sold by the manufacturer may result in a risk of fire, electric shock, or injury to persons.
3. The inverter is designed to be connected to your AC and DC electrical systems. The manufacturer recommends that all wiring be done by a certified technician or electrician to ensure adherence to the local and national electrical codes applicable in your jurisdiction.
4. To avoid a risk of fire and electric shock, make sure that existing wiring is in good condition and that wire is not undersized. Do not operate the inverter with damaged or substandard wiring.
5. Do not operate the inverter if it has been damaged in any way.
6. This unit does not have any user-serviceable parts. Do not disassemble the inverter except where noted for connecting wiring and cabling. See your warranty for instructions on obtaining service. Attempting to service the unit yourself may result in a risk of electrical shock or fire. Internal capacitors remain charged after all power is disconnected.
7. To reduce the risk of electrical shock, disconnect both AC and DC power from the inverter before attempting any maintenance or cleaning or working on any components connected to the inverter. Turning off the inverter/charger using the Inverter Power button on the front panel will not reduce an electrical shock hazard.
8. The inverter must be provided with an equipment-grounding conductor connected to the AC input ground.
9. Do not expose this unit to rain, snow, or liquids of any type. This product is designed for indoor use only. Damp environments will significantly shorten the life of this product and corrosion caused by dampness will not be covered by the product warranty.
10. To reduce the chance of short-circuits, always use insulated tools when installing or working with this equipment.
11. Remove personal metal items such as rings, bracelets, necklaces, and watches when working with electrical equipment.

DANGER

ELECTRICAL SHOCK AND FIRE HAZARD

Installation must be done by qualified personnel to ensure compliance with all applicable installation and electrical codes and regulations. Instructions for installing the Freedom HFS Sine Wave Inverter/Charger are provided here for use by qualified personnel only.

Failure to follow these instructions will result in death or serious injury.

DANGER

HAZARD OF ELECTRIC SHOCK, EXPLOSION, OR ARC FLASH

- Apply appropriate personal protective equipment (PPE) and follow safe electrical work practices. See NFPA 70E or CSA Z462.
- This equipment must only be installed and serviced by qualified electrical personnel.
- Turn off all power supplying this equipment before working on or inside equipment.
- Always use a properly rated voltage sensing device to confirm power is off.
- Replace all devices, doors, and covers before turning on power to this equipment.

Failure to follow these instructions will result in death or serious injury.

WARNING

FIRE AND EXPLOSION HAZARD

- Unit's components may produce arcs or sparks.
- Do not install near batteries, in machinery space, or in an area in which ignition-protected equipment is required.

Failure to follow these instructions can result in death or serious injury.

Areas include any space containing gasoline-powered machinery, fuel tanks, as well as joints, fittings, or other connections between components of the fuel system.

CAUTION

ELECTRICAL SHOCK AND FIRE HAZARD

- Do not open. No serviceable parts inside. Provided with integral protection against overloads. Bonding between conduit connections is not automatic and must be provided as part of the installation.
- Read manual before installing or using.
- Do not cover or obstruct ventilation openings.
- Do not mount in zero-clearance compartment – overheating may result.
- Do not expose to rain or spray. This inverter/charger is designed for marine applications only when additional drip protection is installed in certain orientations. See Installation Guide for more information.
- Use GFCIs only as specified in the manuals supplied with unit. Other types may fail to operate when connected to this unit.
- Charge only properly rated (such as 12 volts) lead-acid (GEL, AGM, Flooded, or lead-calcium) rechargeable batteries because other battery types may explode.
- Do not connect AC OUT to any other source of power. Damage to unit may occur.
- For AC IN and AC OUT, use wires suitable for at least 75°C.

Failure to follow these instructions can result in minor or moderate injury.

NOTES:

1. Follow these instructions and those published by the battery manufacturer and the manufacturer of any equipment you intend to use in the vicinity of the battery. Review cautionary markings on these products and on the engine.
2. Freedom HFS inverter/charger products are designed for deep cycle lead-acid batteries only. Charging lithium-ion batteries are currently not supported and doing so is an explosion hazard. Lithium-ion battery cells are individually monitored for voltage and temperature. The Freedom HFS does not support this individual cell monitoring on lithium-ion batteries.
3. Do not use transformerless battery chargers in conjunction with the inverter/charger due to overheating.

CAUTION

PHYSICAL INJURY HAZARD

This Freedom HFS Sine Wave Inverter/Charger is not intended for use by persons (including children) with reduced physical, sensory, or mental capabilities or lack of experience and knowledge, unless they have been given supervision or instruction concerning use of the appliance by a person responsible for their safety. Children should be supervised to ensure that they do not play with the appliance.

Failure to follow these instructions can result in minor or moderate injury.

Precautions When Working With Batteries

IMPORTANT: Battery work and maintenance must be done by qualified personnel knowledgeable about batteries to ensure compliance with battery handling and maintenance safety precautions.

WARNING

BURN FROM HIGH SHORT-CIRCUIT CURRENT, FIRE AND EXPLOSION FROM VENTED GASES HAZARDS

- Always wear proper, non-absorbent gloves, complete eye protection, and clothing protection. Avoid touching your eyes and wiping your forehead while working near batteries. See note #4.
- Remove all personal metal items, like rings, bracelets, and watches when working with batteries. See notes #5 and #6 below.
- Never smoke or allow a spark or flame near the engine or batteries.
- Never charge a frozen battery.

Failure to follow these instructions can result in death or serious injury.

NOTES:

1. Mount and place the Freedom HFS Sine Wave Inverter/Charger unit away from batteries in a well ventilated compartment.
2. Always have someone within range of your voice or close enough to come to your aid when you work near a lead-acid battery.
3. Always have plenty of fresh water and soap nearby in case battery acid contacts skin, clothing, or eyes.

4. If battery acid contacts skin or clothing, wash immediately with soap and water. If acid enters your eye, immediately flood it with running cold water for at least twenty minutes and get medical attention immediately.
5. Use extra caution to reduce the risk of dropping a metal tool on the battery. It could spark or short circuit the battery or other electrical parts and could cause an explosion.
6. Batteries can produce a short circuit current high enough to weld a ring or metal bracelet or the like to the battery terminal, causing a severe burn.
7. When removing a battery, always remove the negative terminal from the battery first for systems with grounded negative. If it is grounded positive, remove the positive terminal first. Make sure all loads connected to the battery and all accessories are off so you don't cause an arc.

Precautions When Preparing to Charge

WARNING

EXPOSURE TO CHEMICALS AND GASES HAZARD

- Make sure the area around the battery is well ventilated.
- Make sure the voltage of the batteries matches the output voltage of the inverter/charger.
- Be careful to keep corrosion from coming into contact with your eyes and skin when cleaning battery terminals.

Failure to follow these instructions can result in death or serious injury.

NOTES:

- Study and follow all of the battery manufacturer's specific precautions, such as removing or not removing cell caps while charging, whether equalization is acceptable for your battery, and recommended rates of charge.
- For flooded non-sealed batteries, add distilled water in each cell until battery acid reaches the level specified by the battery manufacturer. This helps to purge excessive gas from cells. Do not overfill. For a battery without removable cell caps, carefully follow manufacturer's instructions.

Precautions When Placing the Inverter/Charger

WARNING

FIRE AND BURN HAZARDS

Do not install the inverter/charger or any part of its supplied wiring in engine compartments.

Failure to follow these instructions can result in death or serious injury.

CAUTION

BURN HAZARD

Avoid touching the external surfaces - heatsink may be hot.

Failure to follow these instructions can result in minor or moderate injury.

NOTICE

RISK OF DAMAGE TO THE INVERTER/CHARGER

- Never allow battery acid to drip on the inverter/charger when reading gravity, or filling battery.
- Never place the Freedom HFS Sine Wave Inverter/Charger unit directly above batteries; gases from a battery will corrode and damage the inverter/charger.
- Do not place a battery on top of the inverter/charger.

Failure to follow these instructions can damage the unit and/or damage other equipment.

Regulatory

The Freedom HFS Sine Wave Inverter/Charger is certified to appropriate US and Canadian standards. For more information see “Regulatory Approvals” on page 41.

The Freedom HFS Sine Wave Inverter/Charger is intended to be used for mobile or commercial applications. This inverter/charger is designed for marine applications only when additional drip protection is installed in certain orientations. See the section on Specifications for information.

KKK Information to the User

The Freedom HFS 1055 120VAC EMS and 2055 120VAC EMS models are marked “KKK-A-1822D Ready”. These models are marketed for use in ambulances and emergency vehicle applications. For information of compliance of the ambulance as a whole, please refer to specifications as laid out in Federal Specification for the Star-of-Life Ambulance also known as KKK-A-1822.

FCC Information to the User

This equipment has been tested and found to comply with the limits for a Class B digital device, pursuant to part 15 of the FCC Rules. These limits are designed to provide reasonable protection against harmful interference in a residential installation. This equipment generates, uses, and can radiate radio frequency energy and, if not installed and used in accordance with the instructions, may cause harmful interference to radio communications.

However, there is no guarantee that interference will not occur in a particular installation. If this equipment does cause harmful interference to radio or television reception, which can be determined by turning the equipment off and on, the user is encouraged to try to correct the interference by one or more of the following measures:

- Reorient or relocate the receiving antenna.
- Increase the separation between the equipment and receiver.
- Connect the equipment into an outlet on a circuit different from that to which the receiver is connected.
- Consult the dealer or an experienced radio/TV technician for help.

CAUTION

Unauthorized changes or modifications to the equipment could void the user's authority to operate the equipment.

Contents

Important Safety Instructions	iii
Introduction	1
Features	4
Freedom Inverter/Charger Configuration	9
Freedom Inverter/Charger Operation	16
Operating in Shore Power Mode	18
Operating in Inverter Mode	19
Operating During Transition Between Shore Power and Inverter Mode	22
Battery Charging	25
Invert Power Derating vs. Ambient Temperature	28
Troubleshooting	29
Warning Messages	30
Troubleshooting Reference	33
Inverter Applications	37
Specifications	39

Introduction

The Freedom HFS Sine Wave Inverter/Charger (Freedom HFS) is designed with integrated inverting–charging functions and power management features suitable for marine, recreational, and commercial vehicle installations.

Please read this chapter to familiarize yourself with the main performance and protection features of the Freedom HFS.

Materials List

The Freedom HFS base package includes the minimum following items:

- one Freedom HFS unit
- one set of owner's and installation guides
- one display panel with 7-inch (0.17 m) cable
- one 25-foot (7.5 m) communications cable
- two DC terminal covers
- two strain-relief bushings
- one GFCI cover plate
- one pair AC compartment cover plates
- one display panel blanking plate (not shown)
- one display panel mounting bezel (not shown)
- one set of lock washers and nuts (not shown)

NOTE: If any of the items are missing, contact Xantrex or any authorized Xantrex dealer for replacement. See “Contact Information” on page i.

Other Freedom HFS OEM models may include other DC and/or AC connectors.

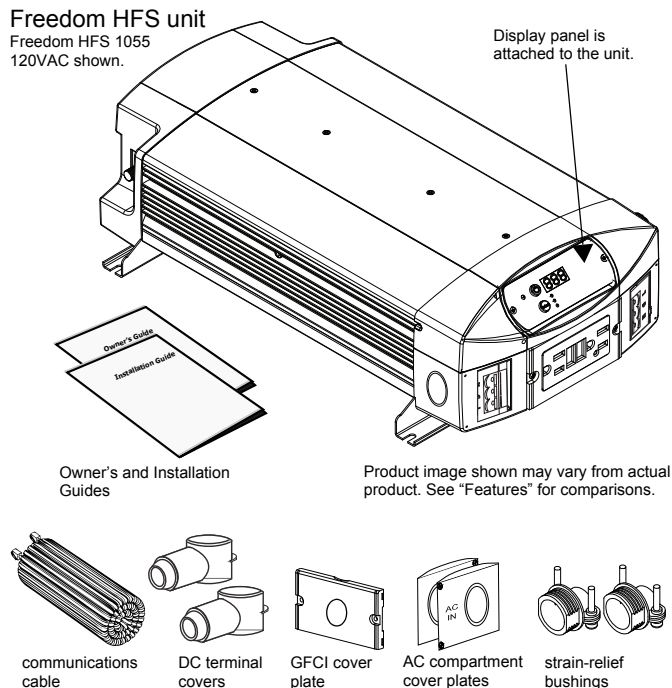

Figure 1 What's In The Box

Key Features

Power for Most Appliances The Freedom HFS inverter/charger provides up to 1000 watts^a or up to 2000 watts^b of continuous utility grade, sine wave power derived from a battery bank. It is designed to handle loads such as microwave ovens, TVs, DVD/Blu-ray players, and power tools. In addition, the Freedom HFS's high-surge capability lets you handle many hard-to-start loads, including large TVs and small refrigerators.

The built-in transfer switch automatically transfers between inverter power and shore power from recreational facilities such as boat docks or campsites to ensure power is always available.

The built-in charger also automatically charges the battery bank when the Freedom HFS is connected to shore power.

Comprehensive Protection The Freedom HFS's built-in protection features safeguard your batteries and equipment, such as:

- the low battery voltage alarm and shutdown prevents your batteries from becoming completely discharged
- the three-stage charging capability ensures that batteries receive efficient charge
- when shore power is available, inverter power switches automatically to shore power in milliseconds allowing continuous operation of connected equipment

Back-up Capability If incoming shore power is interrupted by external events like brownouts, the Freedom HFS automatically becomes an independent power source^c that supplies utility grade AC power to your loads.

Overload Alarm and Shutdown During inverter mode, the Freedom HFS automatically alerts you if the loads that are connected and drawing power from the unit are close to approaching the maximum operating limit. If so, the Freedom HFS automatically shuts down when the maximum operating limit is exceeded.

a. Freedom HFS 1055 120VAC (PN: 807-1055) and Freedom HFS 1055 120VAC EMS (PN: 807-1055-02).

b. Freedom HFS 2055 120VAC (PN: 807-2055), Freedom HFS 2055 120VAC Truck (PN: 807-2055-01), and Freedom HFS 2055 120VAC EMS (PN: 807-2055-02).

c. Assuming the inverter/charger is connected to a battery source with an adequate charge at the time of the power interruption.

Over temperature Alarm and Shutdown During inverter mode, the Freedom HFS automatically alerts you if it is overheating and approaching the over-temperature shutdown limit.

The Freedom HFS automatically shuts down when the limit is exceeded.

Low Power Consumption When the Freedom HFS is inverting without a load, it draws less than 0.6 amp of current from the battery (or battery bank).

This feature allows the unit to operate without draining too much stored energy.

Battery-friendly Charging For the inverter to perform effectively, the batteries must be charged correctly. The Freedom HFS has a built-in three-stage charging system that extends the life and optimizes the performance of the batteries.

In addition to the numerous features which let you maximize your battery's life and performance, the Freedom HFS—unlike many chargers—also has the ability to recharge a near-zero^a voltage battery and an ignition-switched 20-amp auxiliary 12-volt power source^b.

a. Near-zero or dead batteries can be recharged. However, some batteries which have been left uncharged for days can become severely damaged thus, recharging is futile.

b. Available on the Freedom HFS 1055 120VAC EMS model (PN: 807-1055-02) and Freedom HFS 2055 120VAC EMS model (PN: 807-2055-02). The inverter/charger features a 20-amp fused and switched output voltage supplied from the inverter/charger's positive terminal. When connected to a vehicle's ignition signal, a switched positive voltage is available to power auxiliary circuits that are required to operate only when the vehicle is operational.

Selectable Low Battery Shutdown The low battery shutdown for the inverter can be manually selected by the user by choosing a low (10.5 V), middle (11.8 V), or high (12.1 V) setting.

Ignition Control The Freedom HFS provide two user-selectable ignition control method:

- **Ignition Lockout:** The Freedom HFS features the ability to inhibit the inverter from operating in the absence of a voltage signal from a vehicle's ignition circuit. This is particularly useful if the inverter is required to operate only when a vehicle's engine is running.
- **Ignition Auto-on:** The Freedom HFS can automatically turn the inverter on and off with the vehicle's ignition circuit.

Inverter Power Save The Freedom HFS has the ability to automatically turn off after 25 hours of continued operation of loads that are under 50 watts. It is designed to, in conjunction with LBCO, to prevent the battery from deep discharge.

Features

Table 1 lists the default settings for the Freedom HFS system.

You may record your settings in the right-hand column after you have configured the Freedom HFS.

Table 1 Freedom HFS Default Values

Item	Default Setting	Your Setting
Alarm*	ON (<i>AL 1</i>)	
Low Voltage Shutdown*	<i>5dL</i>	
Invert Mode*	<i>l n l</i>	
Battery Type*	<i>FLd</i> Flooded (14.4/13.5)	
Charger Current*	55 A	
Inverter Ignition Control	OFF	

* adjustable from the display panel

Front Panel (Standard Models)

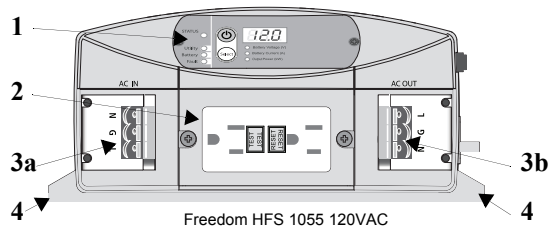

Feature	Description
1	Display panel displays inverter status and battery status information on the screen. The panel can be detached to extend and mount the panel on a wall or other location.
2	GFCI receptacles during inverter mode provide 1000 watts (Freedom HFS 1055 models) or 2000 watts (Freedom HFS 2055 models) of power to operate AC devices.
3	WAGO^a AC terminals (with terminal inspection covers) for connecting AC input (3a) and AC output (3b) wiring.
4	Mounting flange allows you to mount the inverter permanently.

a. WAGO manufactures connection devices such as terminal blocks and related accessories. Freedom HFS models indicated above use WAGO terminal blocks as AC input and output connections.

Front Panel (Truck Model)

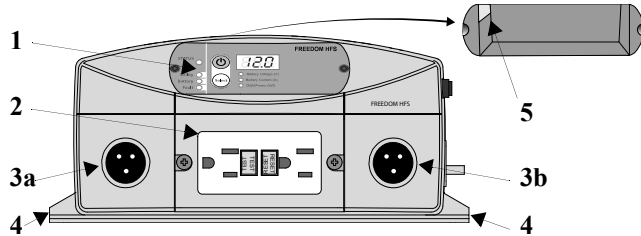

Feature	Description
1	Display panel displays inverter status and battery status information on the screen. The panel can be detached to extend and mount the panel on a wall or other location.
2	GFCI receptacles provide 2000 watts (Freedom HFS 2055 120VAC Truck) of power to operate AC devices. The GFCI unit can be detached and reinstalled to a separate location. Replace the GFCI unit with the GFCI blanking plate. The GFCI unit is also removed to access the AC wiring compartment for hard wiring the inverter to an existing AC power system.
3	(3a) Male PTI[®] Connector for plugging in a compatible AC Input cordset cable with a female PTI plug. (3b) Female PTI Connector for plugging in a compatible AC Output cordset cable with a male PTI plug.
4	Mounting flange allows you to mount the inverter permanently.
5	Display panel cavity for routing the communications cable. See Step 7 of the installation guide.

a. Phillips & Temro Industries manufactures accessories for heating, cooling, silencing, emission and hybrid/electric vehicle technologies. The electrical cables with PTI connectors referred to in this manual are custom cables that are available for the trucking industry.

Front Panel (EMS Models)

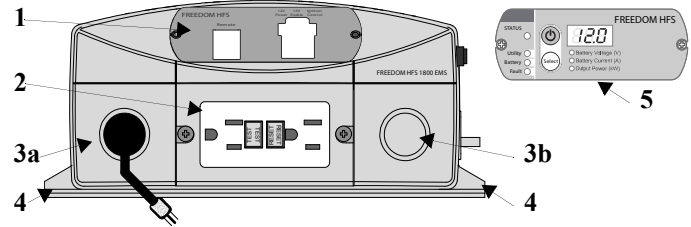

Feature	Description
1	Power module contains 12-volt DC terminals for ignition controls, an auxiliary power source, and a remote port for attaching the display panel using a communications cable.
2	GFCI receptacles provide 1000 watts (Freedom HFS 1055 120VAC EMS) and 2000 watts (Freedom HFS 2055 120VAC EMS) of power to operate AC devices. The GFCI unit can be detached and reinstalled to a separate location. Replace the GFCI unit with the GFCI blanking plate. The GFCI unit is also removed to access the AC wiring compartment for hard wiring the inverter to an existing AC power system.
3	(3a) 18-inch (0.45m) AC Input electrical cord with 3-prong plug. (3b) Knockout for routing AC output wiring.
4	Mounting flange allows you to mount the inverter permanently.
5	Display panel displays inverter status and battery status information on the screen. Mount the panel on a wall or other location.

Rear Panel (EMS Models)

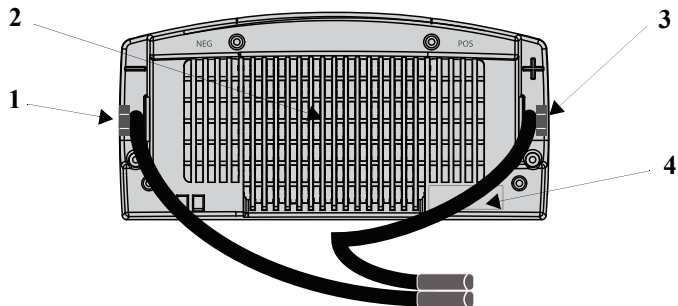

Rear Panel (All Other Models)

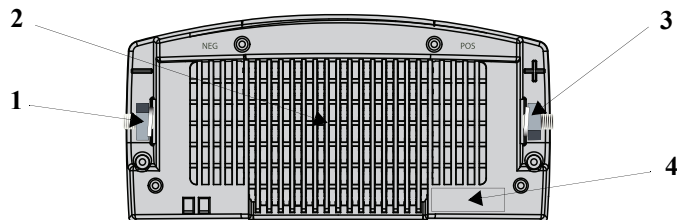

Freedom HFS 1055 shown

Feature	Description
1	Negative DC cabling terminal that is pre-connected to an 18-inch (0.45m) battery cable ^a with an Anderson ^b connector.
2	Ventilation grille (openings) must not be obstructed for the proper operation of the cooling fan and inverter. When the inverter is mounted, the ventilation grille must not point up or down.
3	Positive DC cabling terminal that is pre-connected to an 18-inch (0.45m) battery cable ^a with an Anderson connector.
4	Serial number of your unit.

Feature	Description
1	Negative DC cabling terminal connects to the negative terminal of the battery using a battery cable.
2	Ventilation grille (openings) must not be obstructed for the proper operation of the cooling fan and inverter. When the inverter is mounted, the ventilation grille must not point up or down.
3	Positive DC cabling terminal connects to the positive terminal of the battery using a battery cable.
4	Serial number of your unit.

a. Freedom HFS 1055 120VAC EMS has a cable size of 2 AWG with SB175 Anderson connector and Freedom HFS 2055 120VAC EMS has a cable size of 2/0 AWG with SB350 Anderson connector.

b. Anderson Power Products® manufactures power interconnects and accessories. An Anderson connector is a term used in this manual to mean a connector manufactured by Anderson Power Products and refers to either SB175 or SB350.

Display Panel (All Models)

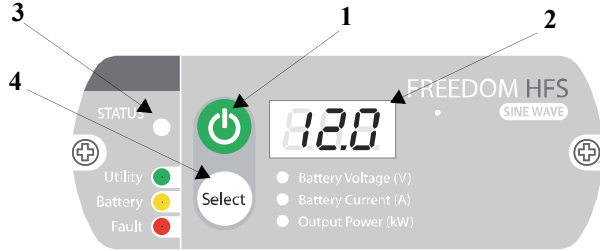

Remote and Power Module Panel (EMS Models)

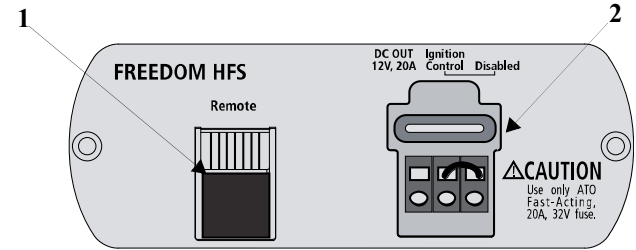

Feature	Description
1	Inverter Power button is the main unit switch that turns the Freedom HFS's inverter mode ON or OFF. See page 16 for additional information.
2	Three-digit LED display screen shows status information and fault codes. See page 16 for additional information.
3	Status LED indicates the mode of operation with a three-color LED. See page 16 for additional information.
4	Select button changes status information displayed on the display screen. See page 16 for additional information.
IMPORTANT: See "Display Panel Operation" on page 16 for detailed information on operating the panel's buttons.	

Feature	Description
1	Remote jack is used for connecting the Display panel that ships with the Freedom HFS 1055 120VAC EMS (PN: 807-1055-02) and Freedom HFS 2055 120VAC EMS (PN: 807-2055-02). Each shipment comes with a 25-foot communications cable as well.
2	Power module has one fuse and three contacts for wires that connect to: <ul style="list-style-type: none"> • an auxiliary 12-volt DC OUT terminal, • an Ignition Control terminal, and • a Disabled terminal. NOTE: The Ignition Control and Disabled terminals are connected by a jumper wire that acts to disable ignition control. Removing the jumper wire will enable ignition control.

For instructions on how to enable or disable Ignition Control, see the Installation Guide.

Side Panel (All Models)

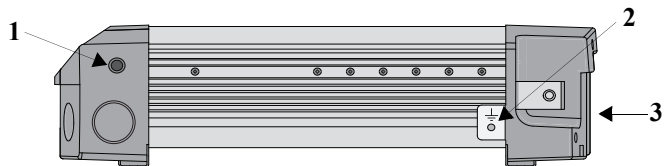

Feature	Description
1	20 A supplementary protector provides overload protection for the GFCI receptacles. In a hard wired installation, the supplementary protector does not protect output wiring. However, for the EMS models, the hard-wired AC output connector is protected by both the 20 A supplementary protector and the GFCI.
2	Grounding stud provides a ground path for the Freedom HFS chassis to the DC system ground.
3	Main cooling fan turns on when powering loads above 500 watts or when the internal temperature reaches a set point temperature.

Freedom Inverter/Charger Configuration

Setting Battery Types on the Main Unit

You can attach different types of lead-acid batteries to the Freedom HFS. Before installing batteries make sure that you configure the unit to optimize the charging process.

The settings can be changed using display panel buttons. See “To adjust the battery type setting:” on page 14.

Battery Type	LED Screen	Bulk/Absorption	Float
Flooded	<i>FLd</i> (default)	14.4	13.5
GEL	<i>9EL</i>	14.2	13.8
AGM	<i>A9</i>	14.3	13.4
Custom	<i>CUS</i>	changeable from 12.0 to 17.0 13.6 (default)	13.6 (default)

Viewing Inverter/Charger Information

The LED screen displays inverter/charger information as well as feature settings in coordination with the LED lights underneath the screen.

- ◆ Press the Select button to toggle between the following basic information:

Info and Setting	LED Screen	Info and Settings LED
Battery Voltage	<i>12.8</i> (example)	Solid – Input Voltage (V)
Battery Current	<i>11</i> (example)	Solid – Input Current (A)
Inverter AC Output Power	<i>0.85</i> (example)	Solid – Output Power (kW)

- ◆ Press and hold the Select button to view advanced setting information. The display automatically exits after 5 seconds.

Info and Setting	LED Screen	Info and Settings LED
Charging Current Setting	<i>5A</i> or <i>15A</i> or <i>35A</i> or <i>55A</i>	none

Info and Setting	LED Screen	Info and Settings LED
Inverter Mode Setting	<i>1 n0</i> or <i>1 n 1</i> or <i>1 n2</i>	none
Alarm Setting	<i>AL0</i> or <i>AL 1</i>	none
Low Voltage Setting	<i>5dL</i> or <i>5dī</i> or <i>5dH</i>	none
Battery Type Setting	<i>FLd</i> or <i>9EL</i> or <i>A9</i> or <i>CU5</i>	none
Custom Voltage Setting ^a	<i>A65</i> <i>12.0</i> to <i>17.0</i> <i>FLt</i> <i>12.0</i> to <i>17.0</i>	none

a. Appears only when the Battery Type setting is set to *CU5*.

Adjusting Feature Settings

The Power and Select buttons can be used to:

- change the charging current setting
- change the inverter mode setting
- disable or enable the audible alarm
- change the shutdown setting
- change the battery type setting
- change custom (CUS) voltage setting^a
- return to factory default settings

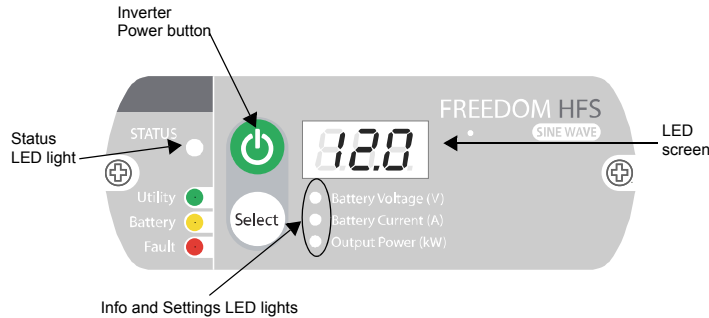

Figure 2 Display Panel

a. Possible only when the Battery Type setting is set to CUS.

To cycle through the various feature settings:

1. Press and hold the Inverter Power button for five seconds to enter the feature settings mode.
2. Press the Inverter Power button to toggle between the following information:

Setting	LED Screen
Charging Current Setting	CUR
Inverter Mode Setting	IN
Alarm Setting	AL
Shutdown Setting	SD
Battery Type Setting	BAT
Custom Voltage Setting ^a	CUS
Factory Setting	DEF

a. Appears only when the Battery Type setting is set to CUS.

To change the charger's charging current setting:

By default the charging current is set to **55A**.

1. Press and hold the Inverter Power button for five seconds.
The LED screen will flash "**CUr**" intermittently.
2. Press the Select button once.
The LED screen will display the present charging current setting. For example, "**35A**" for a 35 A setting.
3. Press the Select button again to change to the next setting.
The LED screen shows the next setting. Example, "**5A**" for a 5 A setting.

AC Input Circuit Breaker or fuse size (Amps)	Charger DC Current Setting (Amps)	Maximum AC Pass-through Current Available (Amps)
15	5A	12.5
	15A	9.5
	35A	4.0
	55A	0

4. Continue pressing the Select button to cycle through each of the available settings – "**5A**", "**15A**", "**35A**", and "**55A**" until you reach the desired setting.
5. Press and hold the Select button for five seconds to make the setting permanent.

To change the inverter mode setting:

By default the inverter mode is set to ON ("**IN1**").

1. Press and hold the Inverter Power button for five seconds.
2. Press the Inverter Power button until the LED screen flashes "**IN**" intermittently.
3. Press the Select button once.
The LED screen will display the present (or most recent) inverter mode setting.

IN1	Inverter mode setting is ON with Power Save feature
IN2	Inverter mode setting is ON without Power Save feature
INO	Inverter mode setting is OFF

4. Continue pressing the Select button to cycle through the three settings – "**IN1**", "**IN2**", and "**INO**" until you reach the desired setting.
5. Press and hold the Select button for five seconds to make the setting permanent.

NOTE: Inverter mode ON (“**I n I**”) will put the inverter on standby with the power save feature. Inverter mode ON (“**I n 2**”) will put the inverter on standby but without the power save feature. Both inverter modes mean that when shore power is present, AC shore power will pass through as AC output. And when shore power is not available, the inverter will take power from the battery and provide AC output power. The inverter is in operation. When the inverter mode is ON, you can manually turn inverter operation ON or OFF by using the Inverter Power button. For information on the Power Save feature, see “Power Save Feature” on page 19.

Inverter mode OFF (“**I n 0**”) completely disables inverter operation. When in this mode, it means that when AC shore power is present, shore power will still pass through as AC output. However, when shore power is not available, inverter operation remains disabled and therefore the unit does not provide AC output power. When the inverter mode is OFF, you cannot manually turn inverter operation ON or OFF by using the Inverter Power button.

To adjust the alarm setting:

By default the alarm is set to ON (“**AL I**”).

1. Press and hold the Inverter Power button for five seconds.
2. Press the Inverter Power button until the LED screen flashes “**AL**” intermittently.
3. Press the Select button once.

The LED screen will display the present (or most recent) alarm setting.

AL I	Sounds the alarm on all detected warning and fault conditions
AL 0	Mutes the alarm

4. Continue pressing the Select button to cycle through the two settings – “**AL 0**” and “**AL I**” until you reach the desired setting.
5. Press and hold the Select button for five seconds to make the setting permanent.

To adjust the low battery shutdown setting:

By default the low battery shutdown voltage setting is set to Low (“**SdL**”).

1. Press and hold the Inverter Power button for five seconds.
2. Press the Inverter Power button until the LED screen flashes “**Sd**” intermittently.
3. Press the Select button once.

The LED screen will display the present (or most recent) low voltage setting. For example, “**SdL**” is for a low shutdown voltage setting.

SdL	low setting = 10.5 V
SdI	middle setting = 11.8 V
SdH	high setting = 12.1 V

4. Continue pressing the Select button to cycle through the three – “**SdL**”, “**SdI**” and “**SdH**” settings until you reach the desired setting.
5. Press and hold the Select button for five seconds to make the setting permanent.

To adjust the battery type setting:

By default the battery type setting is set to Flooded (“**FLd**”).

1. Press and hold the Inverter Power button for five seconds.
2. Press the Inverter Power button until the LED screen flashes “**bAt**” intermittently.
3. Press the Select button once.

The LED screen will display the present (or most recent) low voltage setting. For example, “**FLd**” is for a flooded battery type setting.

FLd	Flooded
AG	AGM
9EL	Gel
CU5	Custom

4. Continue pressing the Select button to cycle through the four – “**FLd**”, “**AG**”, “**9EL**”, and “**CU5**” settings until you reach the desired setting.
5. Press and hold the Select button for five seconds to make the setting permanent.

To adjust the custom battery voltage setting:

NOTE: This setting is possible only when the Battery Type setting is set to **LS**. See “To adjust the battery type setting:” on page 14. There are two voltage settings (Absorption and Float stages) for this Battery Type. By default, the voltage setting of both is set to 13.6 volts (“**13.6**”).

1. Press and hold the Inverter Power button for five seconds.
2. Press the Inverter Power button until the LED screen flashes, for example, “**LS**” intermittently.
3. Press and hold the Select button for five seconds to enter the custom absorption voltage setting screen. The LED screen flashes “**ABS**”.
4. Press the Select button once. The LED screen displays the current absorption voltage. For example, “**13.6**”.
5. Press the Select button to cycle through the available range of values (12.0 to 17.0 in 0.2 increments) until you reach the desired setting.
6. Press and hold the Select button for five seconds to make the Absorption setting permanent.
Then, the LED screen flashes “**FLE**”.
7. Press the Select button once. The LED screen displays the current float voltage setting. For example, “**13.6**”.

8. Press the Select button to cycle through the available range of values (12.0 to 17.0 in 0.2 increments) until you reach the desired setting.
9. Press and hold the Select button for five seconds to make the Float setting permanent.

To return all feature settings to factory default settings:

1. Press and hold the Inverter Power button for five seconds.
2. Press the Inverter Power button until the LED screen flashes “**DEF**” intermittently.
3. Press and hold the Select button for five seconds to return all feature settings to their factory default settings.

Freedom Inverter/Charger Operation

Display Panel Operation

The Freedom HFS features a display panel with three-digit LED display to show inverter, AC source, and battery status information.

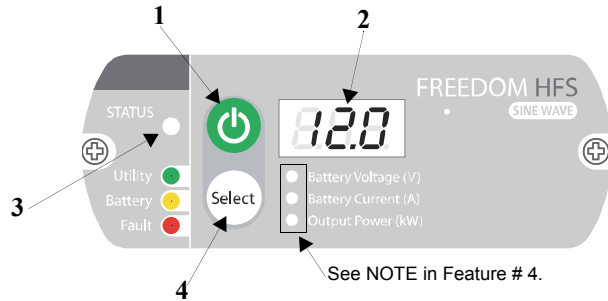

Feature	Description
1	<p>Inverter Power button</p> <ul style="list-style-type: none"> Press and hold for one second to turn the Freedom HFS's inverter operation ON or OFF (when AC Shore Power is NOT present). Press and hold for five seconds to adjust feature settings. Go back to page 11 for instructions.

Feature	Description
2	<p>Three-digit LED display screen shows status information and detected fault codes. Upon startup, the screen shows the display board (U 1.0) and main board (r 1.0) firmware versions.</p>
3	<p>Status LED Indicates the mode of operation with a three-color LED.</p> <ul style="list-style-type: none"> Green pertains to Utility status. <ul style="list-style-type: none"> Solid indicates the Freedom HFS is in shore power mode and battery is fully charged. Flashing indicates the Freedom HFS is in shore power mode and the unit is currently charging the battery. Yellow pertains to Battery status. <ul style="list-style-type: none"> Solid indicates the Freedom HFS is in inverter operation and using the battery to provide AC power. Flashing indicates the Freedom HFS is in inverter operation but AC shore power is detected thus transferring to shore power mode within 20 seconds. Red indicates that a Fault condition has been detected and the Freedom HFS has shut down. See "Troubleshooting Reference" on page 33.

Feature	Description
4	<p data-bbox="207 150 342 165">Select button</p> <ul data-bbox="207 178 792 288" style="list-style-type: none"><li data-bbox="207 178 792 288">• During inverter operation, press the button to choose what appears in the three-digit LED display: Battery Voltage, Battery Current, or Output Power. See “To change the inverter mode setting:” on page 12. <p data-bbox="245 325 773 375">NOTE: A corresponding LED lights up for each of the three items.</p> <div data-bbox="274 394 402 453"></div> <ul data-bbox="280 463 412 525" style="list-style-type: none"><li data-bbox="280 463 412 479">● Battery Voltage (V)<li data-bbox="280 485 412 501">○ Battery Current (A)<li data-bbox="280 506 412 522">○ Output Power (kW) <ul data-bbox="207 538 792 738" style="list-style-type: none"><li data-bbox="207 538 792 618">• In an Alarm condition, press and hold for two seconds to disable (or enable) the audible alarm. See “To adjust the alarm setting:” on page 13.<li data-bbox="207 623 792 738">• During charger operation, press the button to choose what appears in the three-digit LED display: Battery Voltage, Battery Current. See “To change the charger’s charging current setting:” on page 12.

Operating in Shore Power Mode

The Freedom HFS operates in shore power mode when an AC source (a generator or utility power) is present at the AC input terminals. When the AC source is within operating range, the Freedom HFS unit bypasses inverter mode and powers the appliances connected to the unit. See “Transitioning from Inverter Mode to Shore Power” on page 22.

The Freedom HFS also automatically charges the battery bank that is connected while in shore power mode. See “Battery Charging” on page 25.





The Green status LED lights up to indicate that the Freedom HFS is using utility (or generator) power and the battery is full. A flashing Green LED indicates that the unit is charging the battery.

When shore power is present, AC power automatically passes through the Freedom HFS. Pressing the Inverter Power button on the display panel does not interrupt the supply of shore power. Shore Power mode supersedes Inverter operation.

When the Freedom HFS’s Inverter Power button is turned ON and the AC source is outside the operating range or is disconnected, the transfer switch automatically switches to inverter operation. See “Transitioning from Shore Power to Inverter Mode” on page 22.

Operating in Inverter Mode

The Freedom HFS is in inverter operation (operating in inverter mode) when all the following conditions exist:

- inverter power button is ON  
- inverter mode setting is ON 
- shore power is not presently available 
- battery has sufficient power 

Inverter operation means that DC battery power is presently being converted to utility grade AC power, powering equipment and appliances connected to the AC output terminal of the unit.

The Yellow status LED lights up to indicate the Freedom HFS is using the battery to power the equipment and appliances.

Turning Inverter Operation ON and OFF

The Inverter Power button on the display panel turns the Freedom HFS's inverter operation ON or OFF.

- ◆ Press the button and hold for one second.

WARNING

ELECTRICAL SHOCK HAZARD

Turning the Inverter mode setting to OFF and/or turning the Inverter Power button off does not disconnect DC battery power from the Freedom HFS. You must disconnect both AC and DC power before working on any circuits connected to the unit.

Failure to follow these instructions can result in death or serious injury.

To prevent unnecessary battery discharge, turn the Inverter Power button off when you are not using the Freedom HFS.

Power Save Feature

The Power Save feature is a 25-hour countdown that automatically shuts down inverter operation to reduce battery discharge and preserve battery life. During continuous inverter operation, a 25-hour countdown is initiated when power from the AC load drops to less than approximately 50 watts and remains below this level. After 25 hours the inverter automatically shuts down.

To enable this feature the inverter mode setting must be set to "1 n l". See "To change the inverter mode setting:" on page 12.

Status LED During Inverter Operation

The following summarizes the behavior of the Status LED during Inverter operation.

Table 2 Status LED during Inverter Operation

Status LED	Display Screen	Condition
Solid YELLOW	12.8 (where 12.8 is an example of battery voltage)	Select button is pressed to display Input Battery Voltage. The Input Battery Voltage LED lights up. Value in display screen is shown as Volts.
	11 (where 11 is an example of current)	Select button is pressed to display Input Current. The Input Current LED lights up. Value in display screen is shown as Amps.
	0.85 (where 0.85 is an example of output power in Kilowatts)	Select button is pressed to display Output Power. The Output Power LED lights up. Value in display screen is shown as Kilowatts.

Table 2 Status LED during Inverter Operation

Status LED	Display Screen	Condition
Solid RED	E01 through E04	Fault condition detected and AC output power is not available. For details, see Table 5, “Error Codes Displayed on the Display Panel Screen” on page 30.
	E05 through E07	Warning condition detected while AC output power is still available. See Table 5, “Error Codes Displayed on the Display Panel Screen” on page 30.
Off	Off	Inverter operation is OFF.
Off (or Yellow)	00.0	No communication between the Freedom HFS and the Display Panel because the battery voltage was too low to start the Inverter.

Checking Battery Status

During inverter operation, you can check the battery status by pressing the Select button until the Battery Voltage LED (or Battery Current LED) illuminates. The battery voltage (or battery current) appears in the three-digit LED display screen when the Battery Voltage LED (or Battery Current LED) illuminates.

The normal operating battery voltage range is between 11 and 15 volts.

Checking Output Power

During inverter operation, you can check how much power (displayed in kW) the Freedom HFS is supplying to the connected loads by pressing the Select button until the Output Power LED illuminates.

Operating Several Loads at Once

If you are going to operate several loads from the Freedom HFS, turn them on one at a time after you have turned the inverter on.

Turning loads on separately helps to ensure that the inverter does not have to deliver the starting current for all the loads at once, and will help prevent an overload shutdown.

Turning the Audible Alarm ON or OFF

The Freedom HFS's audible alarm can be turned ON or OFF. See "To adjust the alarm setting:" on page 13.

Any warnings such as fault conditions or imminent shutdown are both displayed on the display panel's screen and sounded on the alarm speakers.

It is not possible to turn OFF the screen and prevent it from displaying error codes but it is possible to turn OFF the audible alarm.

NOTE: The alarm setting will reset to its default setting when the Freedom HFS's Inverter Power button is turned OFF then turned ON again.

Operating During Transition Between Shore Power and Inverter Mode

The Freedom HFS's advanced power management is capable of transitioning power from an AC source to DC source within a fraction of a second and vice-versa.

The Freedom HFS automatically detects when shore power is present and when it becomes unavailable or drops to less than 90 volts AC.

Transitioning from Shore Power to Inverter Mode

When the unit is operating in shore power mode and shore power is lost, the Freedom HFS has less than 40 milliseconds to switch to operating in inverter mode and start drawing power from the battery.

The Status LED will turn from solid (or flashing) GREEN to a solid YELLOW.

Transitioning from Inverter Mode to Shore Power

When the unit is operating in inverter mode and shore power becomes available, the Freedom HFS begins a 20-second countdown to verify the stability of the shore power. If shore power remains stable for a 20-second countdown, at the end of the countdown, the Freedom HFS will switch to shore power mode within 40 milliseconds and start drawing power from the AC source.

The Status LED will turn from solid YELLOW to flashing YELLOW during the 20-second countdown, then turn to GREEN when battery power is transitioned successfully to shore power.

Operating Limits

Power Output

The Freedom HFS can deliver up to 1000 watts or 2000 watts of continuous utility grade sine wave AC power. The wattage rating applies to resistive loads such as incandescent lights.

Input Voltage

The allowable Freedom HFS input battery voltage ranges are shown in the following table:

Operating Condition	Battery Voltage Range	Comment
Full Operating Range	Low:10.5–16.5 volts Mid:11.8–16.5 volts High:12.1–16.5 volts	Low refers to low limit of the low voltage threshold. Mid refers to middle limit of the low voltage threshold. High refers to high limit of the low voltage threshold.
Optimum Performance	12.1–13.0 volts	
Low Voltage Alarm	Low: <11.0 volts Mid: <12.3 volts High:<12.6 volts	A silent low battery warning shows fault code <i>E05</i> on the display.
Low Voltage Shutdown	Low: <10.5 volts Mid: <11.8 volts High:<12.1 volts	A single one-second low battery alarm beeps and the display shows fault code <i>E01</i> . After five minutes, the unit shuts down completely.
Instant Low Voltage Shutdown	<10.2 volts	After two seconds below the limit, the unit shuts down and the low battery alarm sounds a long beep continuously for 30 seconds.
High Voltage Shutdown	16.7 volts	The over-voltage alarm beeps every second and the display shows fault code <i>E02</i> alternating with the battery voltage. The status LED turns red and the display screen is turned OFF within 30 seconds to protect itself from excessive input voltage. NOTE: Although the Freedom HFS incorporates over-voltage protection, it can still be damaged if input voltage exceeds 16.7 volts.

Overload Conditions

There are two kinds of overload conditions:

- an overload warning
- an overload shutdown

Overload Warning When the Freedom HFS's AC load is approximately 100 W below the overload shutdown limit of ~1000 W (for Freedom HFS 1055 models) or ~2000 W (for Freedom HFS 2055 models), the audible alarm beeps once every two seconds and the display screen shows a fault code *E05*.

Overload Shutdown When the Freedom HFS's AC load increases to near ~1100 W (for Freedom HFS 1055 models) and ~2100 W (for Freedom HFS 2055 models), the audible alarm beeps every second and the display screen shows a fault code *E03*. The Status LED turns solid RED and in 30 seconds, both the unit and the display screen will shut down to prevent damage to the inverter and protect the battery from being over-discharged.

High Surge Loads

Some induction motors used in freezers, pumps, and other motor-operated equipment require high surge currents to start. The Freedom HFS may not be able to start some of these motors even though their rated steady state current draw is within the inverter's limits. The unit will shut down and indicate an overload shutdown.

Over-temperature Conditions

During inverter operation, when the Freedom HFS's internal temperature starts to approach its preset shutdown limit, the alarm will beep every two seconds and the display will show fault code *E07*. If the over-temperature condition persists, the alarm will beep once per second and the display will show fault code *E04*. The Status LED turns solid RED and the inverter will shut down to prevent damage to the inverter and protect the battery from being over-discharged. However, when the internal temperature drops and falls within normal operating temperature, the Freedom HFS will recover automatically and will continue inverting.

During AC shore power mode, when the Freedom HFS's charger temperature starts to approach its limit, the charging current will be reduced to 20 amps. If the temperature continues to rise, charger output (charging current) is reduced to zero.

Battery Charging

Battery charging is possible only when shore power is present and the Freedom HFS unit is connected to a battery (or battery bank).

The frequency of battery charging is determined by how much energy in the battery is used up during inverting. Whenever the Freedom HFS detects a battery voltage that falls below 12.8 volts, the unit will begin charging the battery, that is, enter into bulk and absorption stages then settle in float stage. If battery voltage does not reach 5 volts after one minute or 10 volts after 15 minutes as shown in the graph, the unit will terminate the charging process and the error code $E 12$ will show on the display screen.

Figure 3 illustrates the three-stage charging process used to maximize Freedom HFS's charging efficiency.

Three-stage charging also applies when Custom Voltage profile is selected.

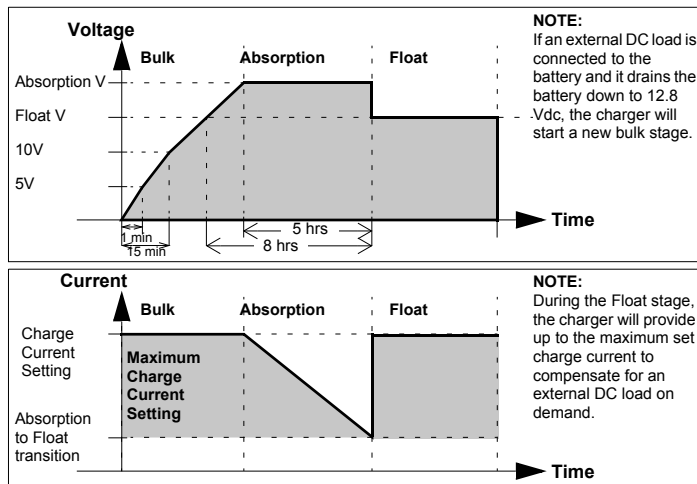

Figure 3 Three-stage Charging Process

Battery Charging

Table 3 illustrates the battery charging status as shown on the Status LED and display screen.

Table 3 Battery Charging Status LED

Status LED	Display Screen	Condition
Solid GREEN	FUL	Battery is FULL.
Flashing GREEN	bUL — CH9 — 12.8 (where 12.8 is an example of battery voltage)	Battery is in BULK CHARGE.
	Ab5 — CH9 — 14.2 (where 14.2 is an example of battery voltage)	Battery is in ABSORPTION CHARGE.
Solid RED	E 10 to E 12	See Table 5, "Error Codes Displayed on the Display Panel Screen" on page 30.

Table 4 illustrates the battery charging voltage and current settings for all the models.

Table 4 Battery Charging Voltage and Current Settings

Battery Type	Bulk/Absorption (Volts)	Float (Volts)	Charge Current (Amps)	Absorption to Float transition (Amps)
Flooded	14.4	13.5	5, 15 35, 55	2 5
GEL	14.2	13.8	5, 15 35, 55	2 5
AGM	14.3	13.4	5, 15 35, 55	2 5
Custom	13.6 (12.0-17.0)	13.6 (12.0-17.0)	5, 15 35, 55	2 5

Routine Maintenance

Freedom HFS Unit

Minimal maintenance is required to keep your Freedom HFS operating properly. Periodically you should:

- Clean the exterior of the unit with a damp cloth to prevent the accumulation of dust and dirt.
- Ensure that the DC cables are secure and fasteners are tight.
- Make sure the ventilation openings are not clogged.

Batteries

When possible, you should recharge your batteries whenever a low voltage warning or a shutdown occurs with the Freedom HFS. This gives the batteries a much longer life than recharging when the batteries have been almost completely discharged.

Invert Power Derating vs. Ambient Temperature

If the unit is in inverter mode and in elevated ambient temperature above 25 °C, you will have to reduce power draw according to the following chart to avoid over-temperature shutdown.

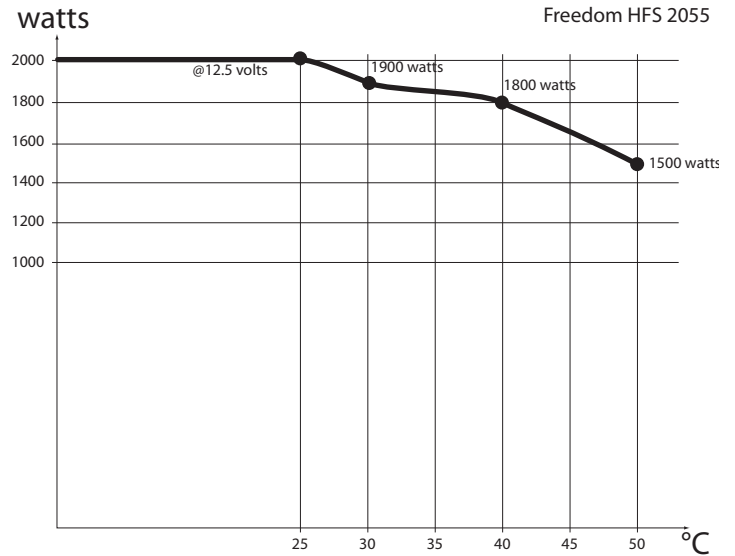
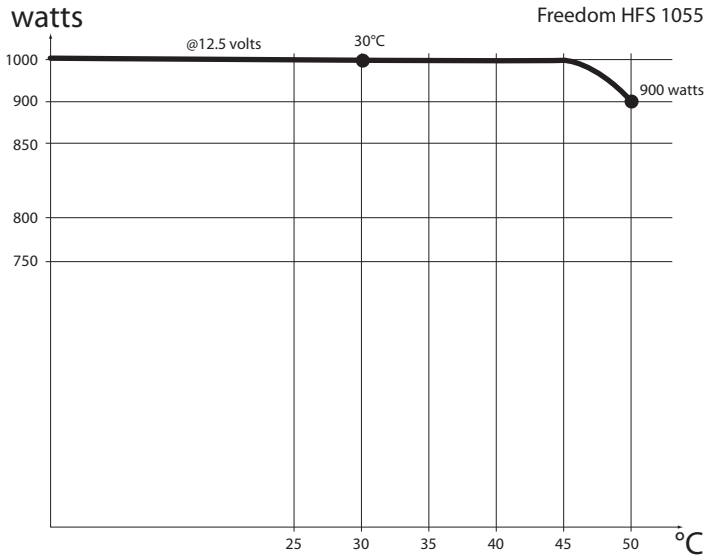

Troubleshooting

WARNING

ELECTRICAL SHOCK AND ENERGY HAZARD

Do not disassemble the Freedom HFS. It does not contain any user-serviceable parts. Attempting to service the unit yourself could result in an electrical shock or burn.

Failure to follow these instructions can result in death or serious injury.

IMPORTANT: To obtain service go to “Contact Information” on page i.

This section will help you narrow down the source of any problem you encounter. Before contacting customer service, please work through the steps listed below:

1. Check for any error codes displayed on the display screen. If a message is displayed, record it before doing anything further.
2. As soon as possible, record the conditions at the time the problem occurred so you can provide details when you contact customer service for help. Include the following information:
 - What loads the Freedom HFS was running or attempting to run
 - What the battery condition was at the time (voltage, state of charge, etc.) if known

- Recent sequence of events
 - Any known unusual AC shore power factors such as low voltage, unstable generator output, etc.
 - Whether any extreme ambient conditions existed at the time (temperature, vibrations, moisture, etc.)
3. If your Freedom HFS is not displaying an error code, check the following to make sure the present state of the installation allows proper operation:
 - Is the inverter located in a clean, dry, adequately ventilated place?
 - Are the battery cables adequately sized as recommended in the Installation guide?
 - Is the battery in good condition?
 - Are all DC connections tight?
 - Are the AC input and output connections and wiring in good condition?
 - Are the configuration settings correct for your particular installation?
 - Are the display panel and the communications cable properly connected and undamaged?
 - Are all disconnects and AC breakers closed and operable?
 - Have any of the fuses blown in the installation?
 4. Contact customer support for further assistance. Please be prepared to describe details of your system installation and to provide the model and serial number of the unit.

Warning Messages

Warning messages in the form of audible alarms and error codes that appear on the display panel screen to alert you to an impending system change. Warnings do not affect operation.

With the exception of the error codes displayed on the screen, only the audible alarm can be turned ON or OFF. Follow the steps in “To adjust the alarm setting:” on page 13 to change the alarm settings.

The error codes are listed in Table 5 below. The text in the **Error Code** column appears on the display screen of the display panel.

Table 5 Error Codes Displayed on the Display Panel Screen

Error Code	Condition	Mode	Action
<i>E01</i>	Low battery voltage shutdown is imminent depending on the setting, see “Operating Limits” on page 23.	Inverting	<ul style="list-style-type: none">• Check battery status and recharge if necessary.• Check for proper DC cable sizing.• Check for loose connections and tighten if necessary.
<i>E02</i>	High battery voltage shutdown > 16.7 volts DC	Inverting	<ul style="list-style-type: none">• Check for external charging sources, such as an over voltage alternator, and disconnect if necessary.
<i>E03</i>	AC output overload shutdown	Inverting	<ul style="list-style-type: none">• Reduce the loads connected to the AC outlet of the unit.• Check appliances that have high-surge ratings and disconnect if necessary.
<i>E04</i>	Over-temperature shutdown	Inverting	<ul style="list-style-type: none">• Reduce the loads connected to the AC outlet of the unit.• Check that the ventilation grille is not blocked.• Check for ambient temperature and move the unit to a cooler location whenever possible.

Table 5 Error Codes Displayed on the Display Panel Screen

Error Code	Condition	Mode	Action
E05	Low battery voltage detected depending on setting, see “Operating Limits” on page 23.	Inverting	<ul style="list-style-type: none"> • Check battery status and recharge if necessary. • Check for proper DC cable sizing. • Check for loose connections and tighten if necessary.
E06	AC output overload warning	Inverting	<ul style="list-style-type: none"> • Reduce the loads connected to the AC outlet of the unit.
E07	Over-temperature warning	Inverting	<ul style="list-style-type: none"> • Reduce the loads connected to the AC outlet of the unit. • Check that the ventilation grille is not blocked. • Check for ambient temperature and move the unit to a cooler location whenever possible.
E08	not used		
E09	not used		
E10	High battery voltage (> 15.5 V)	AC shore power	<ul style="list-style-type: none"> • Check for external charging sources, such as an over voltage alternator, and disconnect if necessary. • Confirm that the external charging source is not the cause. The error may be caused by the internal battery charger system. Call Xantrex for support.
E12	Battery is bad or external DC load is connected to the battery.	AC shore power	<ul style="list-style-type: none"> • Check the battery bank. NOTE: The battery voltage did not rise above 5 volts DC after 1 minute or 10 volts DC after 15 minutes. • Check that the external DC load current consumption is below the charging current setting. • Disconnect the DC load or increase the charger current setting.

Warning Messages

For error code *E01*:

- the display screen and the alarm will turn off after 30 seconds
- after a five-minute shutdown delay, the unit will immediately stop inverting

For error codes *E02* to *E04*:

- the unit will stop inverting

For error codes *E10*:

- the unit will stop charging, but
- the error code will still show on the display screen and the alarm will remain on, and
- AC power will continue to pass through to the AC outlets

For error code *E12*

- the unit will stop charging and shut down, and
- the error code will show on the display screen briefly, and
- AC power will not pass through to the AC outlets

To reset error codes *E10* and *E12*:

1. Remove the AC input.
2. Turn the unit OFF and then turn ON again using the Inverter Power button on the display panel.

Troubleshooting Reference

WARNING

ELECTRICAL SHOCK AND ENERGY HAZARD

Do not disassemble the Freedom HFS. It does not contain any user-serviceable parts. Attempting to service the unit yourself could result in an electrical shock or burn.

Failure to follow these instructions can result in death or serious injury.

Table 6 Troubleshooting Reference

Problem	Possible Cause	Solution
Battery charging current is lower than the charging set point during bulk charge mode.	Ambient (environment) temperature is high.	Do not be alarmed, the unit is performing normally. The charging current automatically de-rates at high ambient temperature. Improve ventilation. Make sure the unit's ventilation openings are not blocked.
Alarm does not sound when an error is encountered.	Alarm is turned OFF.	Press and hold the Select button for two seconds to disable (or enable) the audible alarm. See "Display Panel Operation" on page 16.

Table 6 Troubleshooting Reference

Problem	Possible Cause	Solution
<p>No output voltage. The status LED is red.</p>	<p>AC shore power is not available or out of operating range and the inverter has shut down with the display screen showing one of the following error codes:</p>	
	<ul style="list-style-type: none"> • Low input voltage (fault code E01) 	<ul style="list-style-type: none"> • Check the DC connections and the cable. • Recharge the battery.
	<ul style="list-style-type: none"> • High input voltage (fault code E02) 	<ul style="list-style-type: none"> • Verify the unit is connected to a 12V battery. • Check the voltage regulation of the external charging system (if any).
	<ul style="list-style-type: none"> • Unit overload or AC output short circuit (fault code E03) 	<ul style="list-style-type: none"> • Reduce the load. Make sure the load does not exceed the output rating.
	<ul style="list-style-type: none"> • Thermal shutdown (fault code E04) 	<ul style="list-style-type: none"> • Allow the unit to cool off. • Reduce the load if continuous operation is required. • Improve ventilation. Make sure the inverter's ventilation openings are not blocked.
	<ul style="list-style-type: none"> • AC transfer relay has overheated (during shore power mode). 	<ul style="list-style-type: none"> • Improve ventilation. Make sure the inverter's ventilation grille is not blocked. • Reduce the load.

Table 6 Troubleshooting Reference

Problem	Possible Cause	Solution
<p>No output voltage. The Status LED is green or yellow.</p>	<p>GFCI has tripped or supplementary breaker has tripped.</p> <p>Circuit breaker on the AC load panel or AC output disconnect has tripped.</p> <p>Battery voltage is too low (depending on setting, see “Operating Limits” on page 23) to start inverting. Display screen may show DC voltage as 00.0.</p>	<p>Check load and reset the GFCI or supplementary breaker.</p> <p>Reset the circuit breaker or check the AC output disconnect circuits.</p> <p>Check DC connections and cable. Recharge battery.</p>
<p>No output voltage. The status LED is not lighting up.</p>	<p>AC shore power is not available or out of operating range and the inverter is OFF.</p> <p>AC shore power is not available and the inverter is OFF due to a shutdown for more than 30 seconds.</p> <p>The inverter’s DC input polarity is reversed.</p>	<ul style="list-style-type: none"> • Check AC shore power. • Turn the inverter ON. <ul style="list-style-type: none"> • Check AC shore power and battery voltage. • Turn the inverter ON and look at the display panel for any error code. • See Table 5, “Error Codes Displayed on the Display Panel Screen” on page 30. <p>The inverter was probably damaged due to the reverse polarity. This type of damage is NOT covered by the warranty.</p> <ul style="list-style-type: none"> • Return the unit. • See Warranty Card for information on returning the unit.

Table 6 Troubleshooting Reference

Problem	Possible Cause	Solution
No output voltage. The status LED is not lighting up.	The jumper wire on the power module panel connecting the “Ignition Control” and “Disabled” terminals is removed and there is no ignition signal present.	Ensure the jumper wire is installed if the ignition control feature is not in use. If the ignition control feature is in use, ensure the vehicle’s ignition is on.
The fan turns on and off during AC shore power mode.	<ul style="list-style-type: none"> • The battery is discharged and demands high current from the charger. • AC pass-through current is high. 	Do not be alarmed, the unit is performing normally.
The fan turns on and off during inverter mode.	The inverter is running continuously at high power.	Do not be alarmed, the unit is performing normally. The fan is activated automatically.

Inverter Applications

The Freedom HFS performs differently depending on the AC loads connected to it. If you are having problems with any of your loads, read this section.

Resistive Loads

These are the loads that the inverter finds the simplest and most efficient to drive. Voltage and current are in phase (that is, in step with one another). Resistive loads usually generate heat in order to accomplish their tasks. Toasters, coffee pots, and incandescent lights are typical resistive loads. It is usually impractical to run larger resistive loads—such as electric stoves and water heaters—from an inverter due to their high current requirements. Even though the inverter can most likely accommodate the load, the size of battery bank required would be impractical if the load is to be run for long periods.

Motor Loads

Induction motors (that is, motors without brushes) require two to six times their running current on start up. The most demanding are those that start under load, for example, compressors and pumps. Of the capacitor start motors (typical in drill presses, band saws, etc.), the largest you can expect to run is 1/2 to 1 hp (the transfer relays are rated at 2 hp). Universal motors are generally easier to start. Since motor characteristics vary, only testing will determine whether a specific load can be started and how long it can be run. If a motor fails to start within a few seconds or loses power after running for a time, it should be turned off. When the inverter attempts to start a load that is greater than it can handle, it will turn itself off after a few seconds.

Long Transfer Times The Freedom HFS may take a long time (~ 0.1–0.2 seconds) to transfer to inverter mode when shore power is cut off while powering a motor load. Motor loads typically “freewheel” when power is removed (for example, a grinder) and causes a longer transfer time. The longer transition from shore power to inverter power may cause connected computers or other sensitive equipment to operate incorrectly. To avoid this effect, do not connect motor loads together with sensitive equipment to the inverter for power.

Specifications

NOTE: Specifications are subject to change without prior notice.

Physical Specifications	Freedom HFS 1055 models	Freedom HFS 2055 models
L × W × H	19.2" (487mm) × 9.4" (240mm) × 4.7" (120mm)	19.2" (487mm) × 9.4" (240mm) × 4.7" (120mm)
Net Weight	13.3 lbs (6.05 kg)	14.4 lbs (6.5 kg)

Environmental Specifications	Freedom HFS 1055 models	Freedom HFS 2055 models
Ambient Temperature: Operating Temperature Range Storage Temperature Range	-4 –122 °F (-20 –50 °C), with output derated above 77 °F (25 °C) -40–158 °F (-40–70 °C)	
Humidity: Operation/Storage	5–95% RH, non-condensing	

System Specifications	Freedom HFS 1055 models	Freedom HFS 2055 models
Transfer relay rating	30A, 2.0hp (24A required derating by electrical code in North America)	
Transfer time (shore to inverter)	<40 milliseconds	
Transfer time (inverter to shore)	<40 milliseconds with a 20-second delay	
Transfer voltage (shore to inverter)	<95 V and >135 V	
Transfer voltage (inverter to shore)	<130 V and >100 V	
Cooling	Fan, activated by any of the following: •High internal temperature •High AC output power	

Specifications

NOTE: These are inverter specifications.

DC Input	Freedom HFS 1055 models	Freedom HFS 2055 models
Operating voltage range for all models	10.5–16.5 VDC (low limit) 11.8–16.5 VDC (mid limit) 12.1–16.5 VDC (high limit)	10.5–16.5 VDC (low limit) 11.8–16.5 VDC (mid limit) 12.1–16.5 VDC (high limit)
Safe non-operating voltage range	0–24 VDC	0–24 VDC
Nominal voltage for all models	12.5 VDC	12.5 VDC
Nominal current at full load	92 ADC	200 ADC

AC Output	Freedom HFS 1055 models	Freedom HFS 2055 models
Output voltage range	110–125 VAC	110–125 VAC
Continuous power	1.0kW @ 40 °C	2.0kW @ 25 °C
Continuous current	8.3 A	16.9 A
Surge power	2000 W	4000 W
Max short-circuit current	55 A peak	55 A peak
Frequency	60 Hz	60 Hz
GFCI protection for 120VAC models only	Yes	Yes
Wave shape	True Sine Wave	True Sine Wave
Peak efficiency	≥87%	≥87%
Full load efficiency	≥82%	≥82%

Other	Freedom HFS 1055 models	Freedom HFS 2055 models
No load input power (producing output voltage)	≤10W	≤10W
Off mode current draw	≤4mA	≤4mA

NOTE: These are charger specifications.

AC Input	All models
Operating voltage range	90–140 VAC
Safe non-operating voltage range	up to 240 VAC
Full load maximum current	16 Arms
Nominal frequency	60 Hz

DC Output	All models
Nominal voltage	12.0 VDC
Min battery voltage for charging	0.0 VDC
Max output voltage	17.0 VDC (custom battery type)
Nominal output current	User selectable: 5A, 15A, 35A, 55A
Charger current derating	May reduce charger current depending on ambient temperature.
Efficiency at nominal output	≥75%

Regulatory Approvals	All models
EMC and Safety	ETL listed to CSA 107.1 UL458 and UL458 Marine Supplement (drip shield with product number 808-1050 required) ABYC E11, A20, A25, A31

**Schneider Electric Solar
Inverters USA Inc.**

+1 800 670 0707
+1 408 987 6030
www.xantrex.com

975-0727-01-01

Printed in China